

Joto Digital Mug Press Manual - Single Station includes 7 Elements

Model No.: E-HP-JMP-1S7E

OPERATOR'S MANUAL

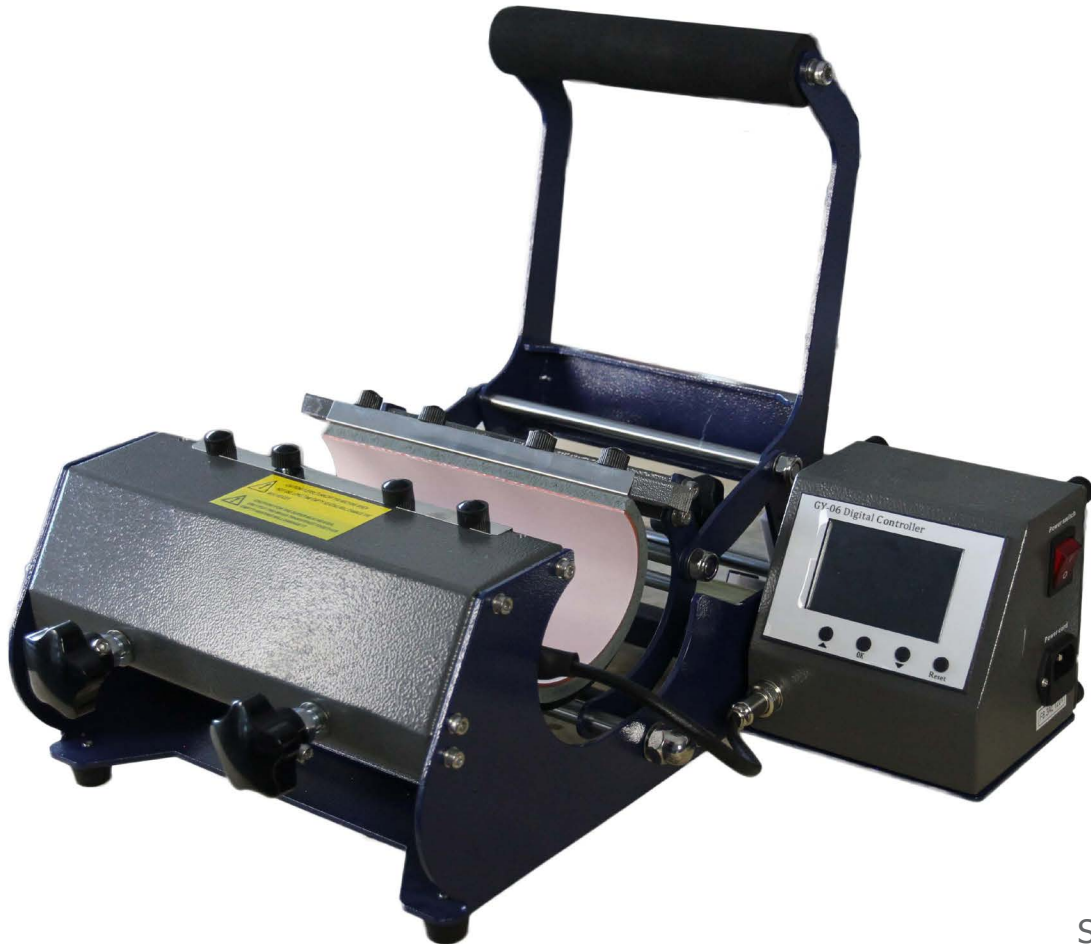

Single Station
Includes 7 elements

JOTOTM
Bringing images to lifeTM

Safety Instructions

For Use By Qualified Personnel Only

When using your Mug Press, basic precautions should always be followed, including the following:

Read all instructions.

Use mug press only for its intended use.

Always keep the mug press dry. Do not get the mug press wet to reduce the risk of electric shock. Avoid storing mug press in a wet/ damp area.

Never pull the cord to disconnect the power. Instead, grasp plug and pull to disconnect from power outlet.

Make sure you protect the power cord by keeping it away from hot surfaces. Avoid placing objects on top of the cord. This could cause damage to the cord and could be a fire hazard risk.

Do not operate mug press with a damaged cord or if the equipment has been damaged. To prevent risks of injury, please do not disassemble or attempt to repair the mug press by yourself if you are not qualified to do so. Instead, call or take it to a qualified service person for examination and repair. Incorrect assembly or repair could increase the risk of fire, electric shock, or injury to persons when the equipment is used.

If mug press being used by or near children, please make sure that it is supervised. Do not leave equipment unattended while connected.

Metal parts on the press can become hot. Avoid touching the hot metal parts to prevent burns. Proceed with caution when using the mug press.

To reduce the likelihood of circuit overload, Joto recommends to use a dedicated circuit if possible.

Make sure that the cord is safely secured so it cannot be pulled or tripped over.

If you need to use an extension cord, make sure you use a 20 amperage rated cord. Cords rated below 20 amperage can overheat. Make sure that the extension cord is safely secured so it cannot be pulled or tripped over.

Note: Temperature is in Fahrenheit or Celsius. This mug press should not be set to exceed 400°F (200°C). Setting the press temperature to above 400°F (200°C) will burn out your mug element and may cause a fire hazard.

Do not use any other power cords other than the one provided with this machine. Doing so may result in a fire hazard. If you need a replacement cord, please call Joto at 1-800-565-5686 to request one.



PLEASE KEEP THE BOX THAT YOUR MUG PRESS ARRIVED IN, ALONG WITH ALL ORIGINAL PACKAGING.

Congratulations on your purchase of a Joto Single Station Mug Press with 7 elements! In order to work professionally with the machine and start production, please make sure you read this manual carefully.

Reproduction of this manual requires written consent from Joto. Errors and amendments of technical details excepted, all rights reserved. Joto is not liable for any direct or indirect damages caused by the use of this product.

Table of Contents

Safety.....	2
Introduction	3
Mug Press Overview	4-5
Machine Parts Diagram	6
Setting Up Your Mug Press.....	7
Elements Overview	8
Operating Instructions	9
Replacing The Mug Element	10
Joto Sublimation Guide	11
Maintenance	11
Expanded View	12-13
Circuit Diagram.....	14
Warranty.....	15
Contact Information	16

Mug Press Overview

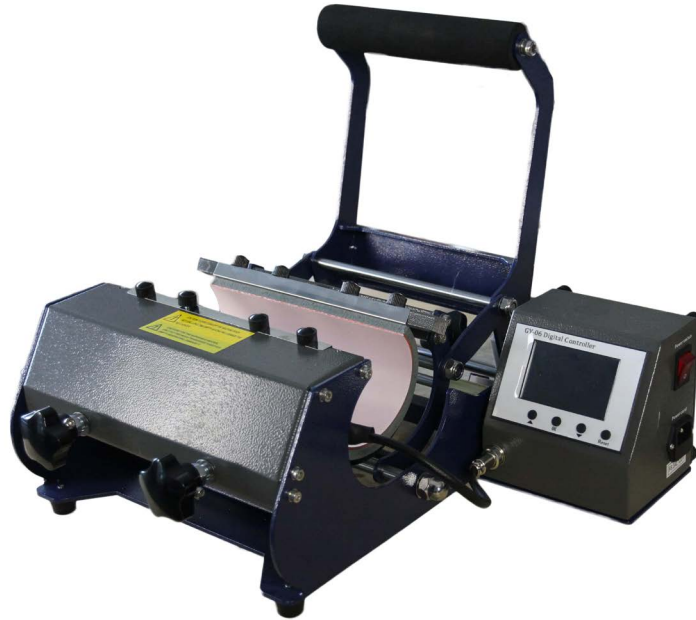

Technical Specs

Model No.:	E-HP-JMP-1S7E
Machine Type:	Single Station Mug Press with 7 Elements
Machine Size:	23.62" x 16.85" x 11.69" (604 x 428 x 297mm)
Printable Articles Max Size:	6" x 4"
Mug Heater Size:	11oz/15oz Mug, Dia. 6-7.5cm for 6oz, 9oz, 10oz etc Mug, Dia. 5-9cm for 11oz, 15oz etc Mug, Tumbler (up to ~8.5" tall), 12oz/17oz Latte ,1.5oz Shot, 2.5oz Espresso Shot
Voltage:	220V/1Phase; 110V/1Phase
Power:	130W, 0.59A
Recommended Settings:	30~280s; 356~400°F (180~200°C) Time Range: 0~999s Maximum Temp: 437°F (225°C)
Packing Size:	18.70" x 13.97"x 12.20" (47.5 x 35.5 x 31cm)
Gross Weight:	21.38lbs (9.70kg)

Note: Temperature is in Fahrenheit or Celsius. This mug press should not be set to exceed 400°F (200°C). Setting the press temperature to above 400°F (200°C) will burn out your mug element and may cause a fire hazard.

Mug Press Overview



TOP VIEW



FRONT VIEW



LEFT VIEW



RIGHT VIEW

Machine Parts Diagram

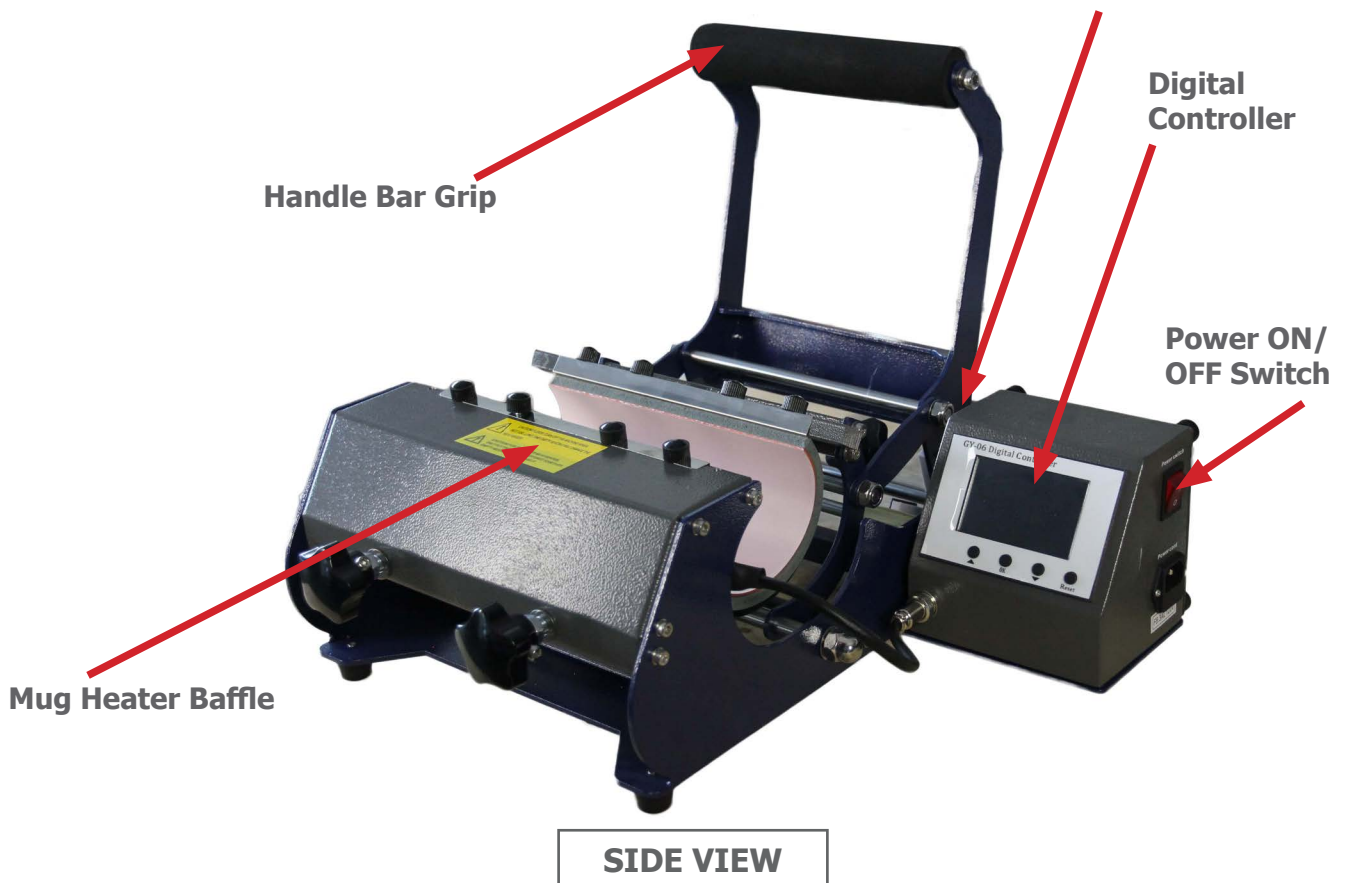
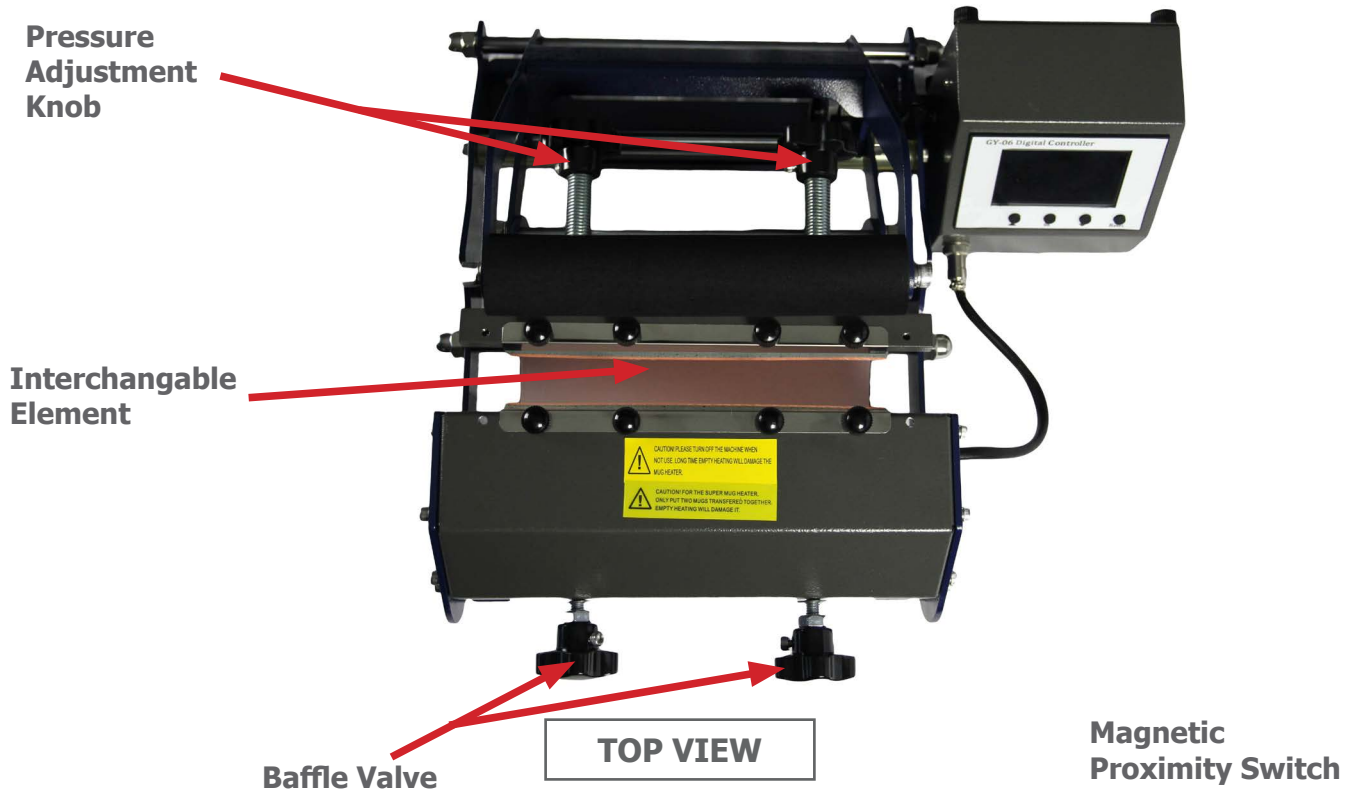

Setting Up Your Mug Press

Turning On Your Mug Press

Turn the Main Power Switch ON. The Main Power Switch is at the right/Left side of the heat press.

Current temperature will display. Usually has the value "LO", indicating low temperature.



How to Read The Display

- 1.) Left side PV value = Current Temperature
- 2.) Right side PV value = Current Time
- 3.) Left side SV value = Set Press Temperature
- 4.) Right side SV value = Set Press Time

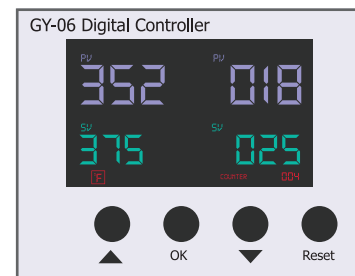

Setting Press Temperature

Press OK to start. Use the up and down arrows to choose to display in °F or °C.
°F stands for Fahrenheit
°C stands for Celsius

Once selection is made, press OK to save

Now use the arrow to change the value of the set temperature. The left light in the middle is lit to indicate you are in the set temperature mode.

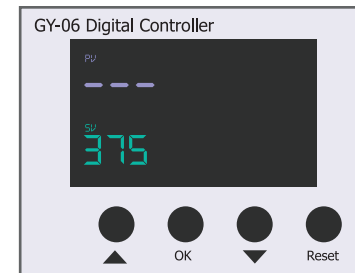

Note: This mug press should not be set to exceed 400°F/ 200°C. Setting the press temperature to above 400°F/ 200°C will burn out your mug element and may cause a fire hazard.

Setting Press Time

Green Set Time Value will flash
Use the up and down arrows to change the value.

Press OK to save the value.

Wait until the current temperature is the same as the set temperature before using. The press will beep once set temperature is reached. Close and open the press to stop the beeping.



Elements Overview



Tumbler Element

SKU: X-HP-JMP61-01

- 20oz SS tumbler with Lid and Straw
- 500ml SS Flask Bottle
- 17oz Coke Shaped Bottle
- Water Bottle with Bamboo lid
- 650ml Aluminium Bottle with Straw
- Stainless Steel Water Bottle
- Aluminum Water Bottle
- 10oz SS Coffee Mug
- 12oz Mason Jar
- 14oz/ 17oz Travel Mug
- 16oz /20oz Beer Stein



6oz-10oz Mug Element

SKU: X-HP-JMP61-02

- 17oz Coke Shaped Bottle
- Water Bottle with Bamboo lid



12oz Latte Element

SKU: X-HP-JMP61-03

- 12oz Latte



11oz/15oz Mug Element

SKU: X-HP-JMP51-01

- 11oz Mug
- 15oz Mug
- 12oz Enamel Cup
- 10oz Bone China Mug with Gold Rim



17oz Latte Element

SKU: X-HP-JMP61-04

- 12oz Wine Cup with Lid
- 16 Stainless Steel Tumbler
- 17oz Latte



1.5oz Shot Element

SKU: X-HP-JMP61-05

- 1.5oz Shot Glass



2.5oz Espresso Shot Element

SKU: X-HP-JMP61-06

Operating Process

Pressing a Drinkware

- 1.) Turn OFF the Power Switch.
- 2.) Change to the correct element (see Page 8), and turn ON the Power Switch.
- 2.) Set the appropriate Press Temperature, and Time.
- 3.) Tape your imaged transfer/sublimation paper to your mug with heat tape.
- 4.) Set the pressure. To do this, place a blank drinkware into the element. Adjust the pressure knob until the drinkware fits snugly in the element with the heat shield wrapped around the bottle (just enough pressure so that the drinkware cannot be moved once press is closed). Turn pressure knob counter-clockwise to tighten and clockwise to loosen.
- 5.) Wait until current temperature is the same as set temperature. Once the mug press is at temperature, place drinkware into the press. Close the mug press.
Note: Ensure the timer starts immediately after closing the press. If it does not, take the bottle out & wait for the temperature to go up to the set temp.
- 6.) Timer will start counting down. The press will beep when the set time has lapsed. When mug press beeps, open mug press and take out your drinkware.
- 7a.) For sublimation, peel immediately and dunk into warm-cold water to stop the sublimation process.
- 7b.) For Hard Surface Papers, Dunk in warm-cold water. Then wait until the mug is cold before peeling.

Please note: To image an 11oz/15oz Mug, you need to purchase Element: X-HP-JMP51-01.

Replacing The Mug Element

Replacing your Mug Element

- 1.) Ensure the power switch is OFF.
- 2.) Unplug the mug press if it is still plugged in.
- 3.) Detach the mug element cord from the mug press. Unscrew the ring that holds the cord in place before detaching. See below diagram for detailed instructions
- 4.) With the Mug Press open, unscrew the eight screws that hold the mug element in place.
- 5.) Gently slide the mug element out of the mug press. Please be careful not to damage the cord or the mug press.
- 6.) Gently slide the new mug element into the mug press.
- 7.) Re-screw the four screws to keep the mug element in place.
- 8.) Connect the new mug element cord to the mug press. Ensure that the pattern on the cord matches the socket on the mug press.

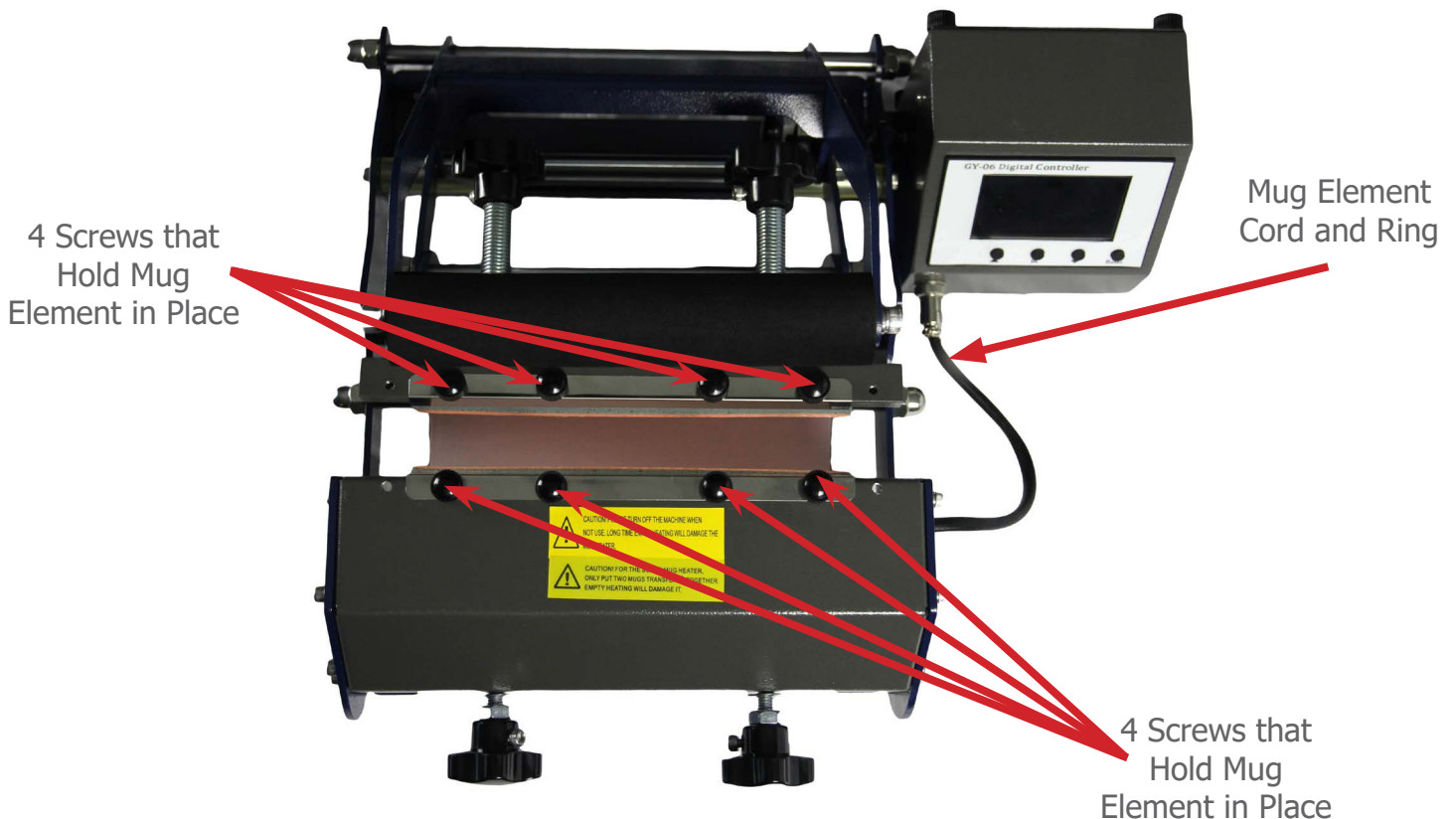

Mug Pressing Guide

11oz Mugs

Temperature: 360°F (180°C)

Time: 150-180 seconds



15oz Mugs

Temperature: 360°F (180°C)

Time: 150-180 seconds



20oz Glass Beer Mug

Temperature: 360°F (180°C)

Time: 240 seconds



16oz Frosted Beer Mug

Temperature: 360°F (180°C)

Time: 240 seconds



Aluminum Water Bottles

Temperature: 320°F (160°C)

Time: 120-140 seconds



Stainless Steel Water Bottles

Temperature: 320°F (160°C)

Time: 120-140 seconds



For more instructions, please visit our website at www.jotoimagingsupplies.com/support/how-to-library/instructions.html

Maintenance

General Maintenance

Please switch off the machine and unplug the power cord when the machine is not in use.

To prolong the life of the mug press, do not use excessive pressure when pressing mugs. If excessive pressure is used, this may damage the mug press or the mug element and cause it to malfunction

Keep the mug press in a dry place at all times.

Mug elements will wear out over time. When they wear out, you will need to replace them with new ones. The rated life expectancy of a mug element is approximately 1000-2000 mugs.

Elements may wear out earlier due to other factors:

- 1.) No mug is in the press when on and the press is closed
- 2.) Physical abuse
- 3.) Environmental factors

Note: Temperature is in Fahrenheit or Celsius. This mug press should not be set to exceed 400°F (200°C). Setting the press temperature to above 400°F (200°C) will burn out your mug element and may cause a fire hazard.



If your mug press stops working, please contact Joto at 1-800-565-5686 so we can help you troubleshoot.

Expanded Diagram

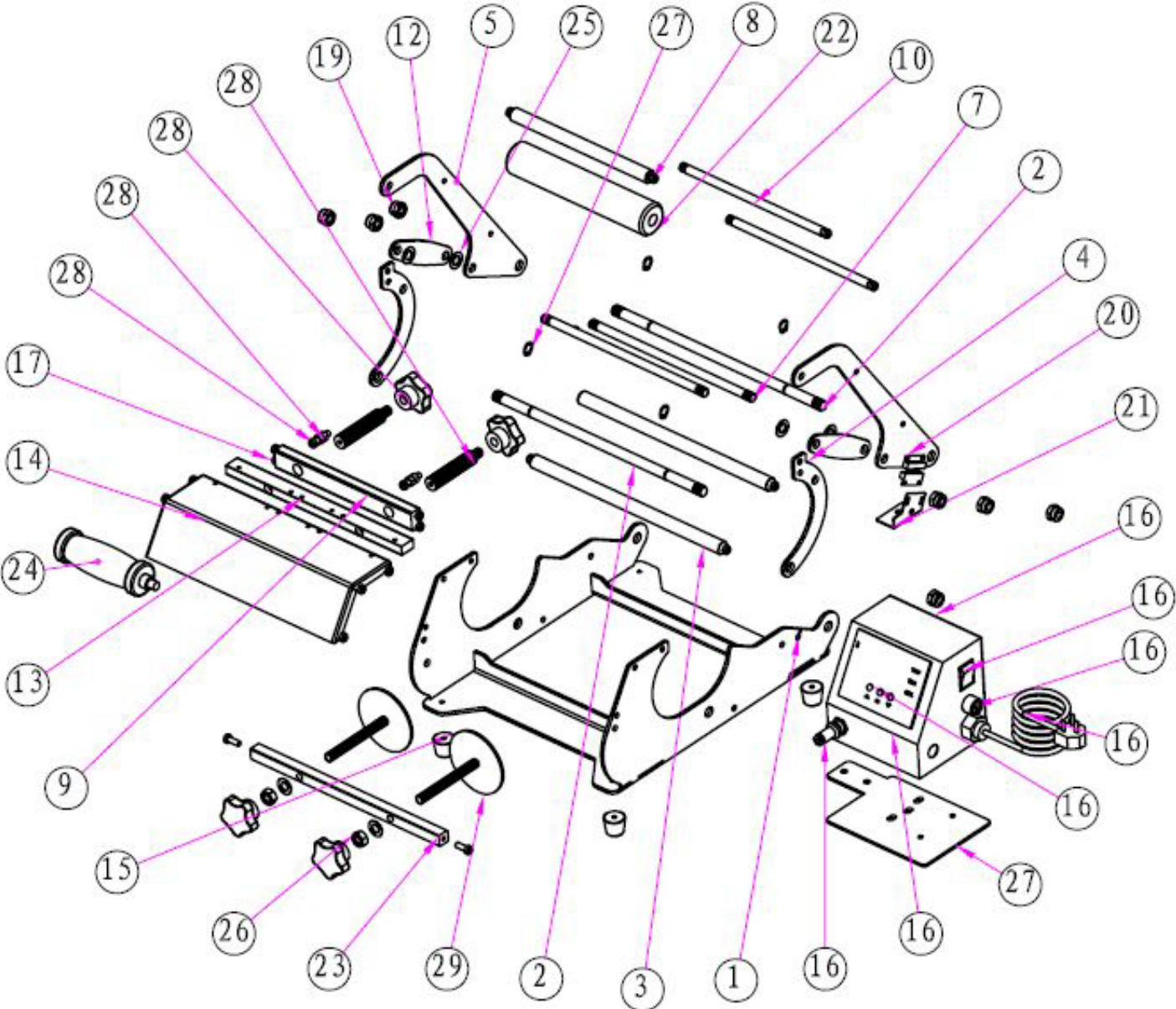

Expanded Diagram

Serial No.	Part Name	Qty
1	Base frame	1
2	Iron bar	2
3	Limited rod	5
4	Semicircle pressure frame	1
5	Handle frame	1
6	Handle frame	1
7	The middle pin	1
8	The handle bar	1
9	Fixed stay	1
10	The middle handle bar pin	4
11	The middle handle bar pin	1
12	Connection strap	1
13	The front pin	1
14	The bending plate	1
15	Rubber foot	2

Serial No.	Part Name	Qty
16	Electrical Case	1
17	GB-HEXAGON-TYPE21-M6X16-16-N	4
18	GB-HEXAGON-TYPE21-M6X16-16-N	1
19	GB-HEXAGON-TYPE9-M10-N	1
20	Magnetic switch	1
21	Magnetic switch	1
22	Handle cover	4
23	Installation panel	1
24	The handle	1
25	GB-FASTENER-WASHER-MWC-10	1
26	GB-FASTENER-NUT-SNAB1 M10-N	1
27	GB-CONNECTING-PIECE-RINGRRA12	
28	Tool kit 1	
29	Tool kit 2	

Circuit Diagram

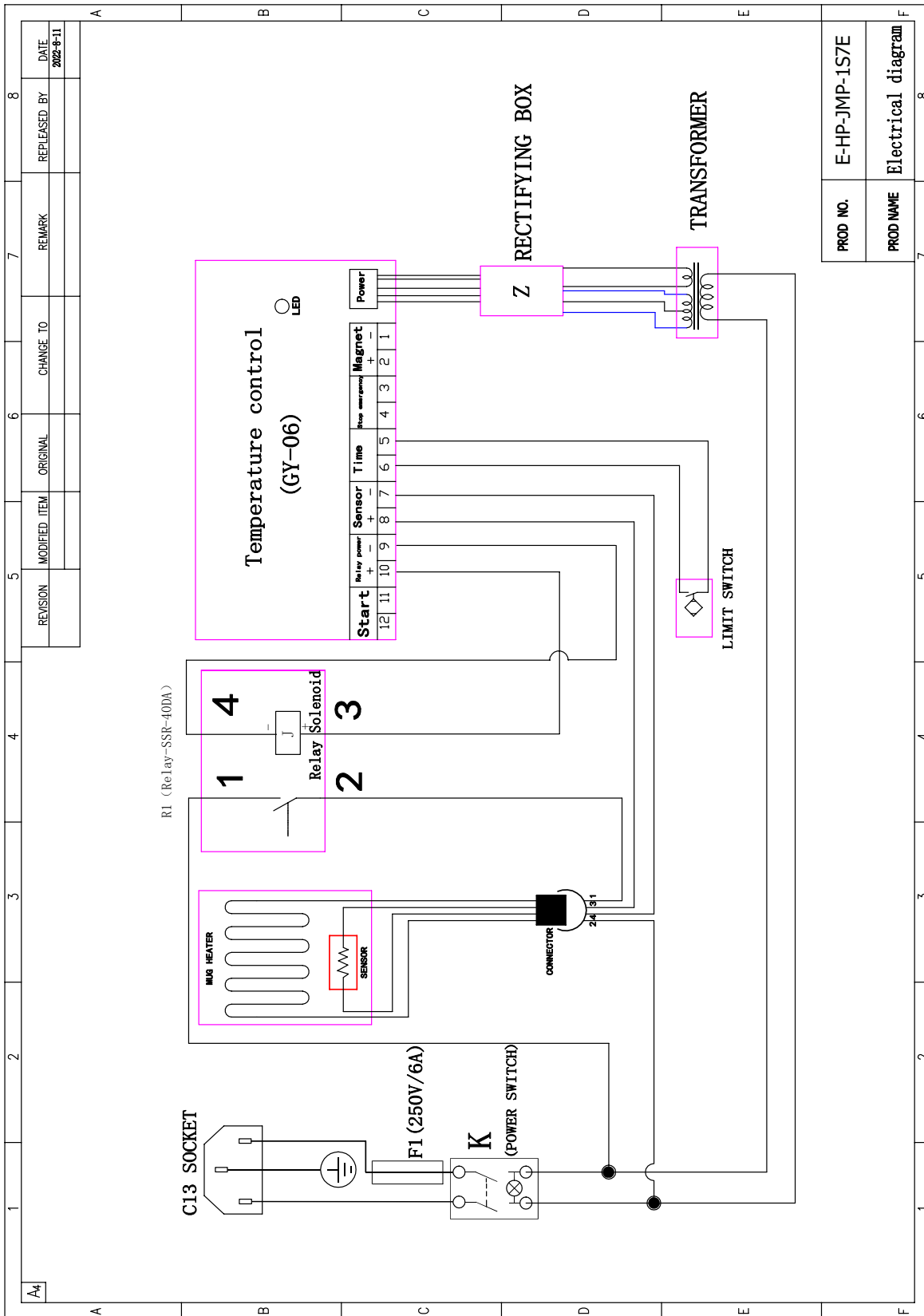

Warranty Statement

JOTO warrants to the original purchaser JOTO's E-HP-JMP-1S7E mug press or component that such mug press or component is free from defects in materials and workmanship, subject to the limitations set forth below.

IN LIEU OF ALL WARRANTIES, EITHER EXPRESS OR IMPLIED, INCLUDING WITHOUT LIMITATION ANY IMPLIED WARRANTY OF MERCHANTABILITY OR FITNESS FOR A PARTICULAR PURPOSE, WHICH JOTO HEREBY DISCLAIMS, THE OBLIGATIONS OF JOTO UNDER THIS WARRANTY ARE EXPRESSLY LIMITED TO THE FOLLOWING:

- a. JOTO will repair or replace at its option, free of charge, any product, component of its products, and any component it sells separately which is installed in JOTO's heat presses, within twelve months and six months for the heating element after shipment by same.
- b. This warranty does not apply to damage incurred in shipment. Damage incurred in shipment should be reported to the designated carrier. It is the carrier's responsibility to ensure arrival in undamaged condition.
- c. Service labor, when requested in connection with any of the above items covered by this warranty, will be charged for traveling expenses only.
- d. This warranty applies only if the product or component proves to be defective under conditions of normal use. It does not apply to breakage or to defects resulting from accident, alteration, misuse, or improper installation.
- e. This warranty does not include installation of the product or component.
- f. Prior to any return of a product or component, Buyer must receive written authorization to do so from JOTO. After written authorization, Buyer shall return the defective product or component freight prepaid by the original purchaser and JOTO will ship the replacement or repaired component freight prepaid by JOTO.
- g. This warranty is effective only if the product or component is installed in a location and manner prescribed by JOTO instructions and only if it is maintained in accordance therewith. This warranty shall become ineffective if the product or component is altered by anyone other than JOTO employees. JOTO neither assumes, nor authorizes any person to assume for it, any obligation or liability other than as specified herein.

JOTO WILL IN NO CASE AND UNDER NO CIRCUMSTANCES BE LIABLE FOR SPECIAL OR CONSEQUENTIAL DAMAGES, LOSS OF PROFIT OR COMMISSION, OR FOR LOSS OR DELAY IN PRODUCTION.

Without limiting the generality of the foregoing, JOTO will not be liable with respect to furnishing or delay in furnishing any product or component, the use, resale, or other disposition thereof, failure to furnish the same, or any other cause. JOTO liability arising out of the supply of any product or component, its use, resale, or other disposition, or out of any guarantee or warranty, express or implied, or any other cause shall in no case exceed the cost to JOTO of the product or component which JOTO has agreed to supply. All liability of JOTO with respect to any product or component shall terminate upon the expiration of the twelve-month period described above.

-Any controversy or claim arising out of or relating to transactions or orders or breach thereof, including breach of warranty, shall be settled by arbitration in Blaine, Washington, pursuant to the rules of American Arbitration Association. Any award made against JOTO shall be limited as provided above. Judgment upon award rendered by arbitration may be entered in any court having jurisdiction thereof. However, at JOTO's option, this paragraph shall not apply to collection by JOTO of the price of any product sold or any action related thereto.



**PLEASE KEEP THE BOX THAT YOUR MUG PRESS ARRIVED IN,
ALONG WITH ALL ORIGINAL PACKAGING.**

JOTOTM



Bringing images to lifeTM

www.jotoimagingssupplies.com

Tel: 1-800-565-5686

Fax: 1-800-565-5622

Coquitlam, BC | Toronto, ON

Blaine, WA | Las Vegas, NV | Antioch TN